

NEATIFY

Komoda

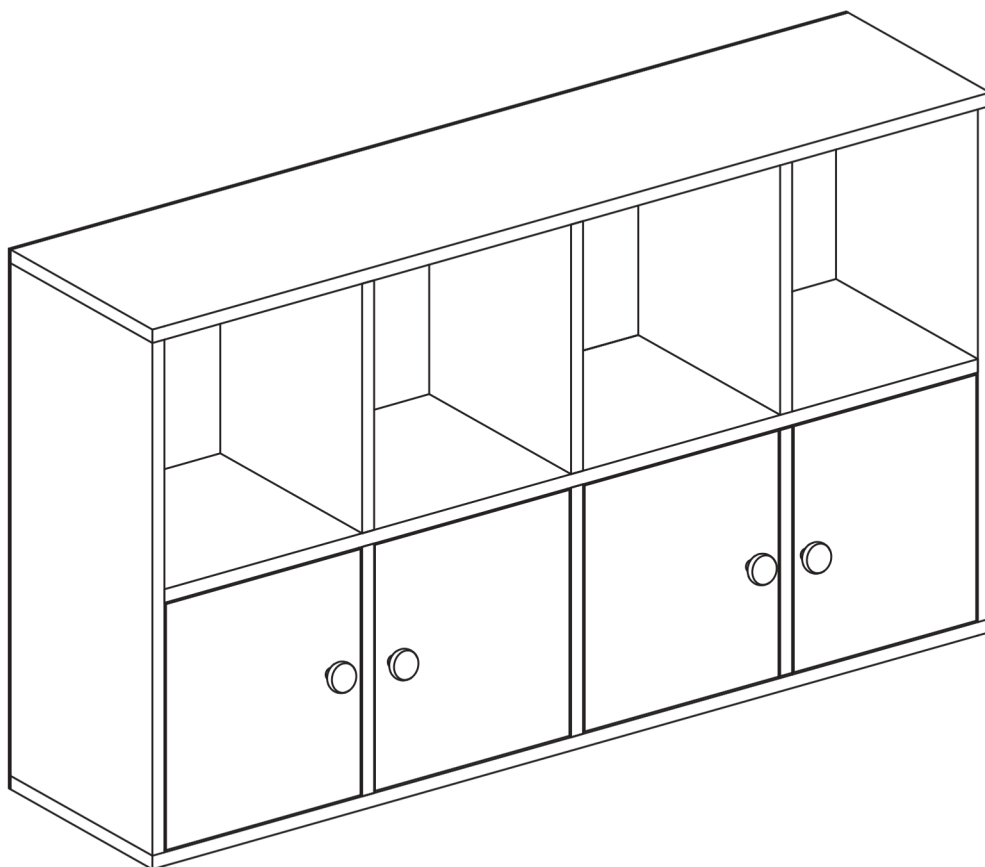

Bosanski

UPOZORENJE

Pretvrtnanje namještaja može da izazove nastanak ozbiljnih ili fatalnih povreda.
UVIJEK pričvrstite ovaj nameštaj za zid koristeći fiksatore.
Da dodatno smanjite opasnost od teških povreda i smrti zbog prevrtanja namještaja:
- Nikad ne dozvoljavajte djeci da se penju niti da vise na ladicama, vratima ili policama.

English

WARNING

Serious or fatal crushing injuries can occur from furniture tip-over.
ALWAYS secure this furniture to the wall using tip-over restraints.
To further reduce the risk of serious injury and death from tip-overs:
- Never let children climb or hang on drawers, doors, or shelves.

Hrvatski

UPOZORENJE

Namještaj koji se prevrne može uzrokovati ozbiljne ili smrtonosne ozljede.
UVIJEK pričvrstite namještaj za zid s pomoću priloženih pričvrstnika.
Za smanjenje rizika od ozbiljnih ili smrtonosnih ozljeda:
- Ne dozvoliti djeci da se penju na ladice, vrata ili police ili vješaju o njih.

Srpski

UPOZORENJE

Pretvrtnanje nameštaja može da izazove nastanak ozbiljnih ili fatalnih povreda.
UVEK pričvrsti ovaj nameštaj za zid pomoću fiksatora koji sprečavaju njegovo prevrtanje.
Da smanjiš opasnost od teških povreda i smrti usled prevrtanja nameštaja:
- Nikad ne dozvoljavaj deci da se penju niti vise na fiokama, vratima ili policama.

Slovenščina

OPOZORILO

Prevrnitev pohištva lahko privede do hudih telesnih poškodb ali smrti.
VEDNO pritrdi ta kos pohištva v steno z varovali proti prevrnitvi.
Dodatni ukrepi za zmanjšanje možnosti resnih ali smrtnih poškodb zaradi prevrnitve pohištva:
- otrokom prepreči, da bi plezali ali se obešali na predale, vrata ali police.

Deutsch

ACHTUNG

Umfallende Möbelstücke können lebensgefährlich sein.
Um diesem Risiko zu entgehen, muss das Möbel UNBEDINGT mit dem beige packten Kippschutz an der Wand befestigt werden.
Um das Risiko schwerer oder gar tödlicher Verletzungen durch umkippende Möbelstück weiter zu mindern, bitte Folgendes beachten:
- Kindern niemals erlauben, auf Schubladen, Türen und Regale zu klettern oder sich daran zu hängen.

Italiano

AVVERTENZA









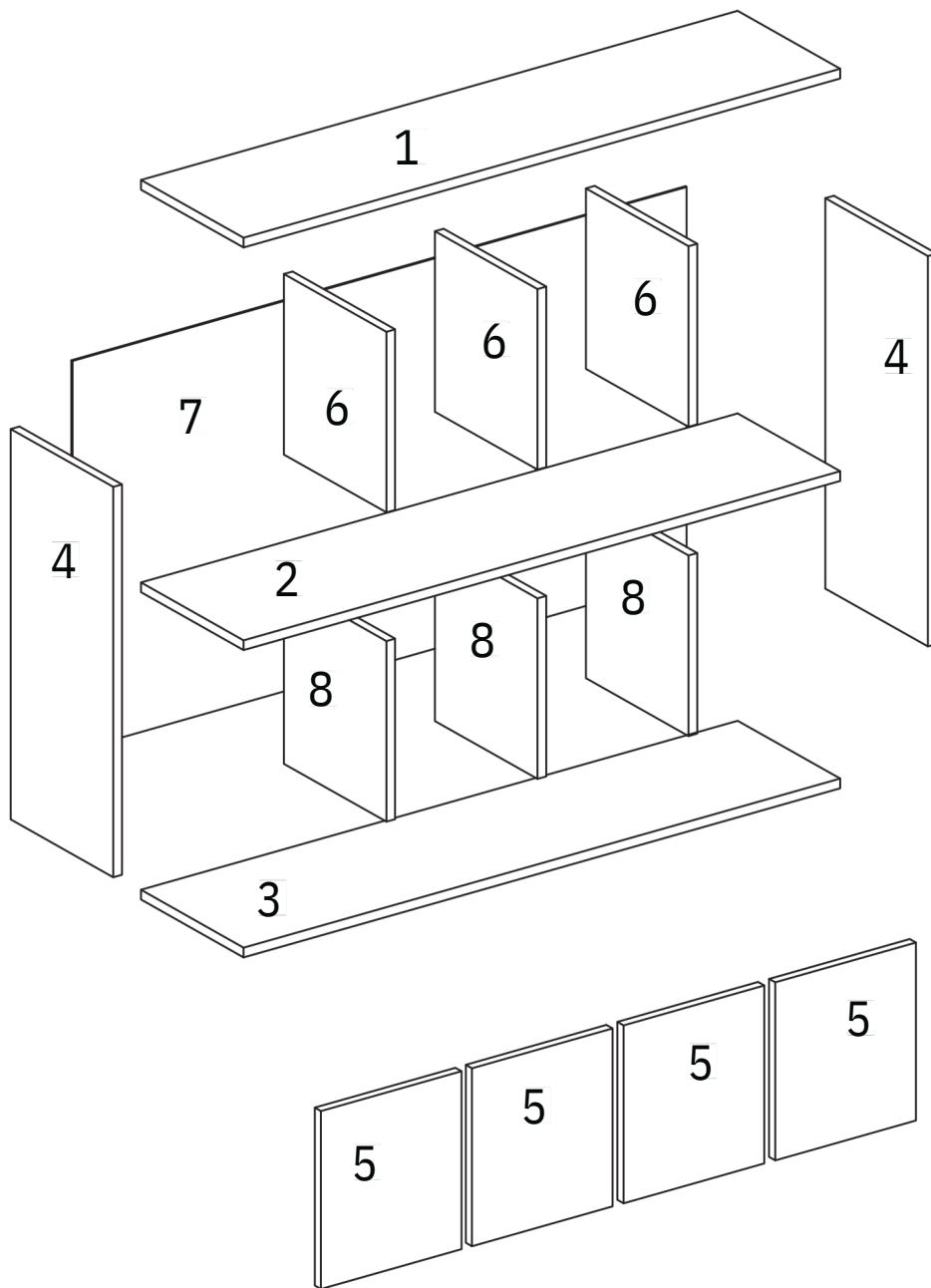

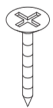
Se il mobile si ribalta può causare lesioni da schiacciamento gravi o mortali.
Fissa SEMPRE questo mobile alla parete usando i componenti di sicurezza. Per ridurre ulteriormente il rischio di lesioni gravi o mortali causate dal ribaltamento:
- Evita che i bambini si appendano o si arrampichino sui cassetti, sulle ante o sui ripiani.

Français

ATTENTION

Risque de blessures graves ou mortelles en cas de basculement du meuble.
TOUJOURS fixer ce meuble au mur à l'aide des fixations antibasculement. Pour encore réduire les risques de blessures graves ou mortelles dus au basculement du meuble:
- Ne jamais laisser les enfants grimper ou s'accrocher aux tiroirs, portes ou tablettes.

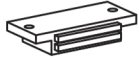

<p>A</p>  <p>*24</p>	<p>B</p>  <p>*40</p>	<p>C</p>  <p>*12</p>	<p>D</p>  <p>*12</p>	<p>E</p>  <p>*4</p>	<p>F</p>  <p>*4</p>	<p>G</p>  <p>*4</p>
<p>H</p>  <p>*4</p>	<p>I</p>  <p>*4</p>	<p>J</p>  <p>*4</p>	<p>K</p>  <p>*4</p>			

01

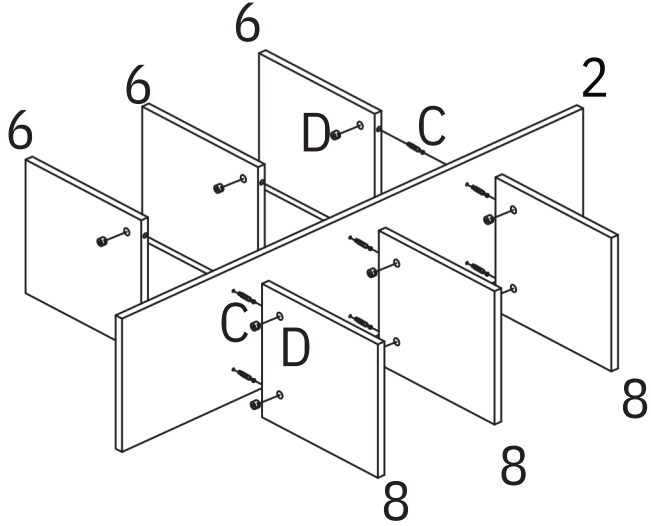
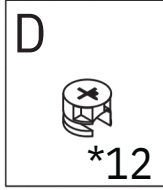
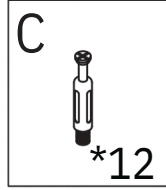

02

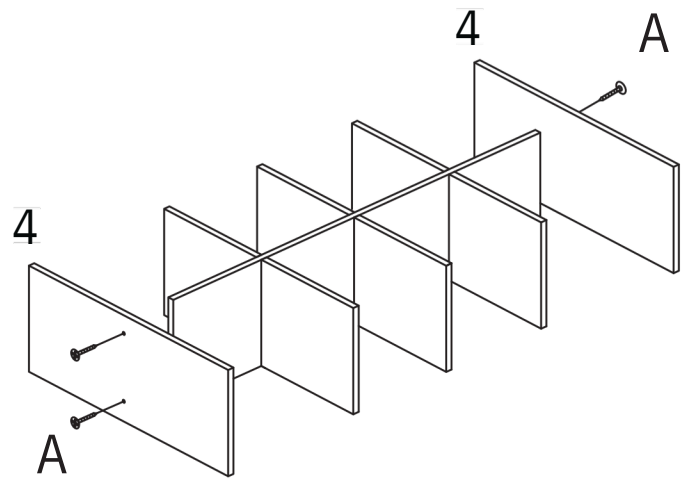
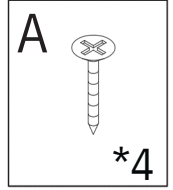

03

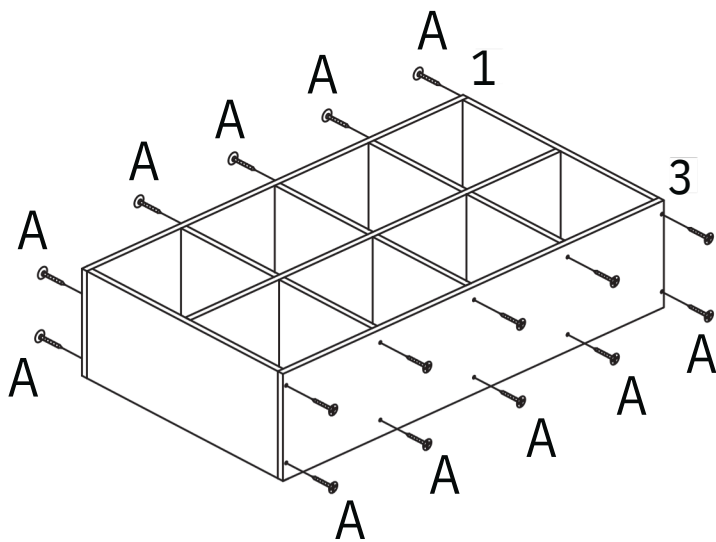
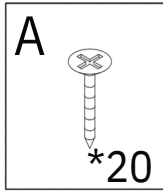

04

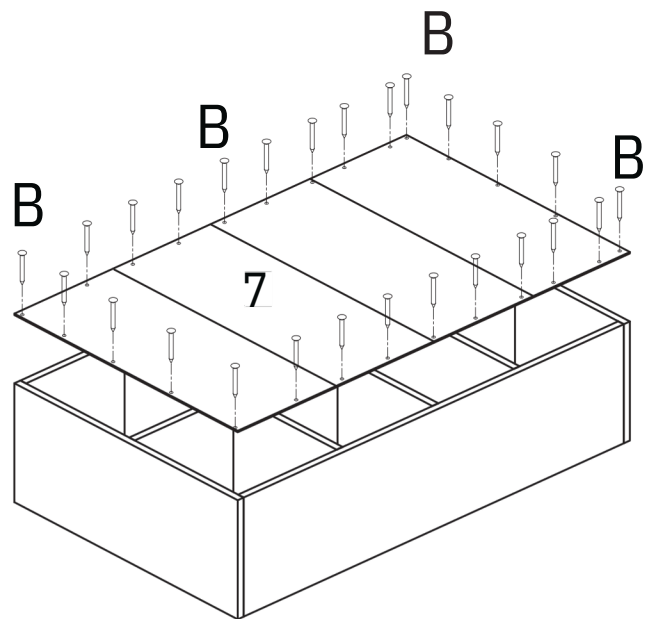
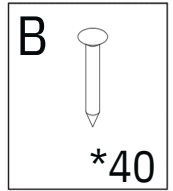

05

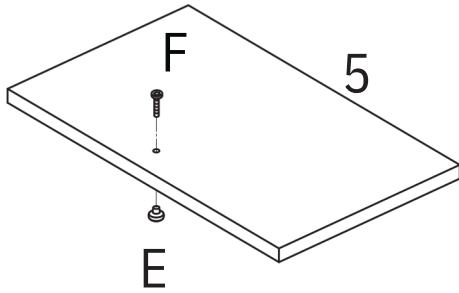
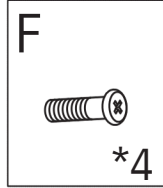
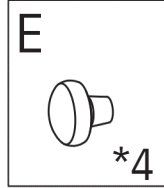

06

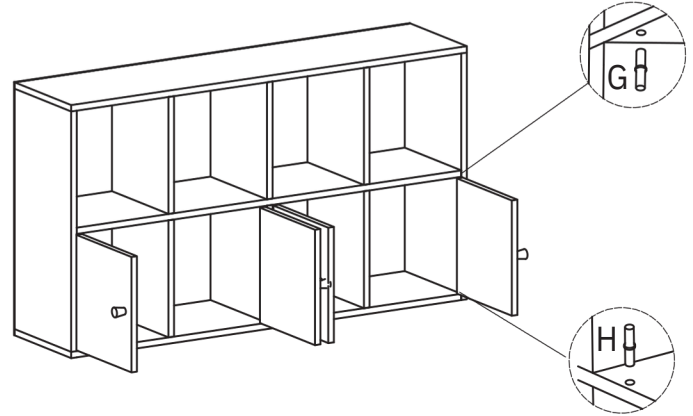
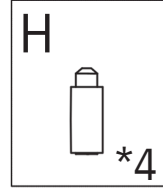
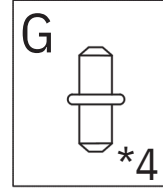

07

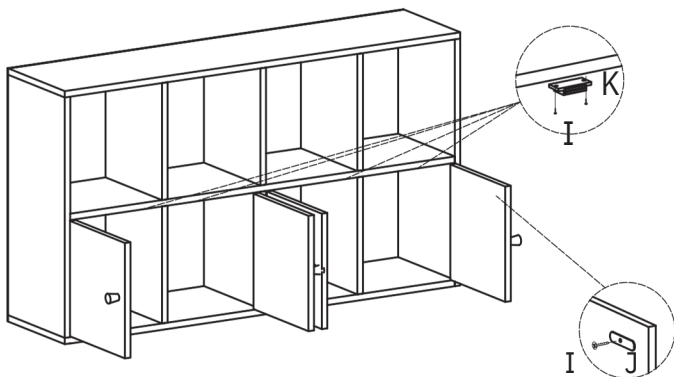
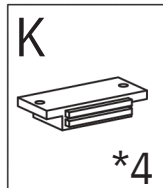
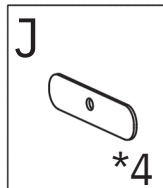
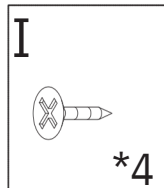

08

