

# PULSAR

Cipelar

Šest polica

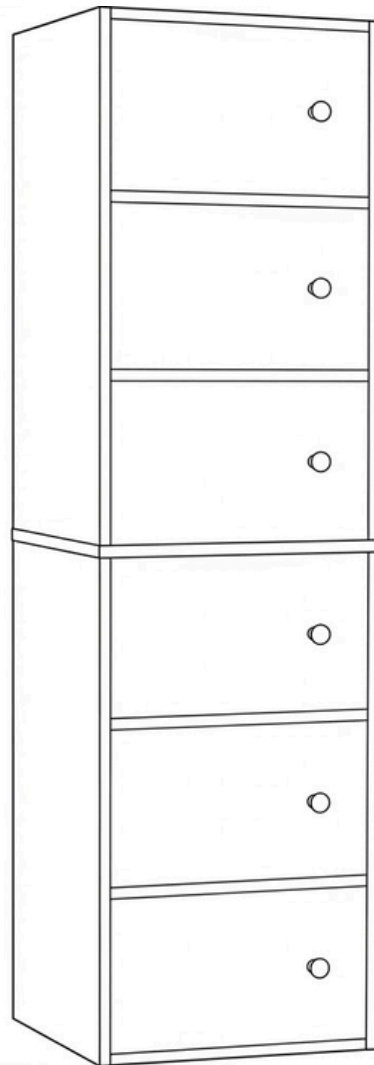



Bosanski

## UPOZORENJE

Pretvrtnje namještaja može da izazove nastanak ozbiljnih ili fatalnih povreda.

**UVIJEK** pričvrstite ovaj nameštaj za zid koristeći fiksatore.

Da dodatno smanjite opasnost od teških povreda i smrti zbog prevrtanja namještaja:

- Nikad ne dozvoljavajte djeci da se penju niti da vise na ladicama, vratima ili policama.

English

## WARNING

Serious or fatal crushing injuries can occur from furniture tip-over.

**ALWAYS** secure this furniture to the wall using tip-over restraints.

To further reduce the risk of serious injury and death from tip-overs:

- Never let children climb or hang on drawers, doors, or shelves.

Hrvatski

## UPOZORENJE

Namještaj koji se prevrne može uzrokovati ozbiljne ili smrtonosne ozljede.

**UVIJEK** pričvrstite namještaj za zid s pomoću priloženih pričvrstnika.

Za smanjenje rizika od ozbiljnih ili smrtonosnih ozljeda:

- Ne dozvoliti djeci da se penju na ladice, vrata ili police ili vješaju o njih.

Srpski

## UPOZORENJE

Pretvrtnje nameštaja može da izazove nastanak ozbiljnih ili fatalnih povreda.

**UVEK** pričvrsti ovaj nameštaj za zid pomoću fiksatora koji sprečavaju njegovo prevrtanje.

Da smanjiš opasnost od teških povreda i smrti usled prevrtanja nameštaja:

- Nikad ne dozvoljavaj deci da se penju niti vise na fiokama, vratima ili policama.

Slovenščina

## OPOZORILO

Prevrnitev pohištva lahko privede do hudih telesnih poškodb ali smrti.

**VEDNO** pritrđi ta kos pohištva v steno z varovali proti prevrnitvi.

Dodatni ukrepi za zmanjšanje možnosti resnih ali smrtnih poškodb zaradi prevrnitve pohištva:

- otrokom prepreči, da bi plezali ali se obešali na predale, vrata ali police.

Deutsch

## ACHTUNG

Umfallende Möbelstücke können lebensgefährlich sein.

Um diesem Risiko zu entgehen, muss das Möbel **UNBEDINGT** mit dem beige packten Kippschutz an der Wand befestigt werden.

Um das Risiko schwerer oder gar tödlicher Verletzungen durch umkippende Möbelstück weiter zu mindern, bitte Folgendes beachten:

- Kindern niemals erlauben, auf Schubladen, Türen und Regale zu klettern oder sich daran zu hängen.

Italiano

## AVVERTENZA

Se il mobile si ribalta può causare lesioni da schiacciamento gravi o mortali.

Fissa **SEMPRE** questo mobile alla parete usando i componenti di sicurezza. Per ridurre ulteriormente il rischio di lesioni gravi o mortali causate dal ribaltamento:

- Evita che i bambini si appendano o si arrampichino sui cassetti, sulle ante o sui ripiani.

Français

## ATTENTION

Risque de blessures graves ou mortelles en cas de basculement du meuble.

**TOUJOURS** fixer ce meuble au mur à l'aide des fixations antibasculement. Pour encore réduire les risques de blessures graves ou mortelles dus au basculement du meuble:

- Ne jamais laisser les enfants grimper ou s'accrocher aux tiroirs, portes ou tablettes.

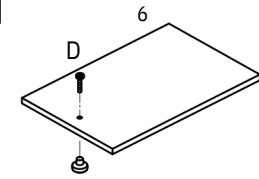
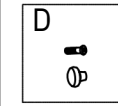
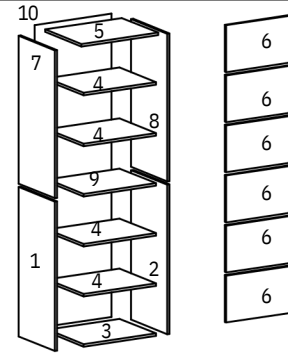
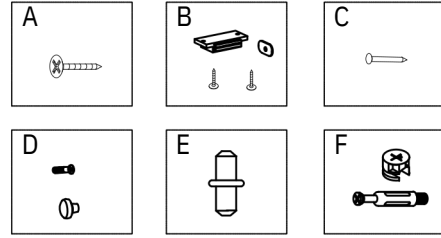

01

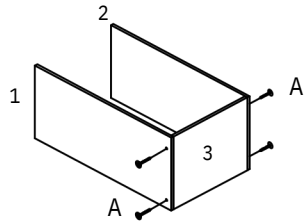
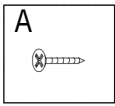

02

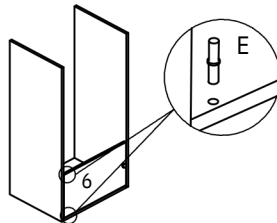
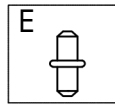

03

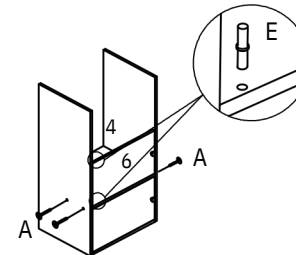
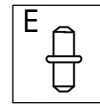
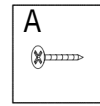

04

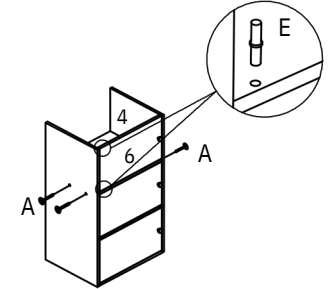
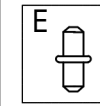
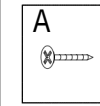

05

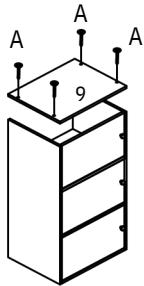
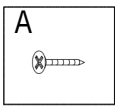

06

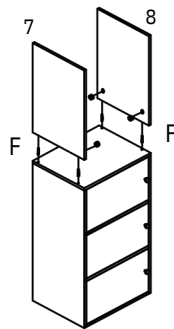
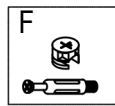

07

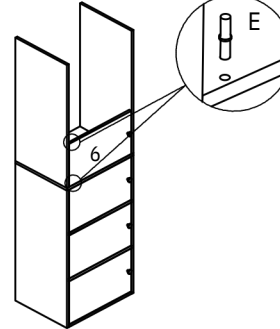
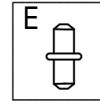

08

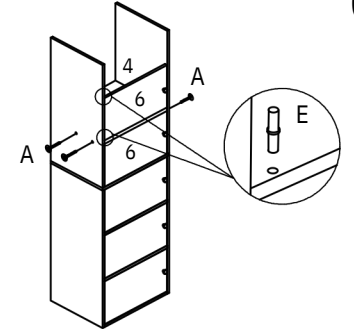
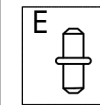
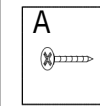

09

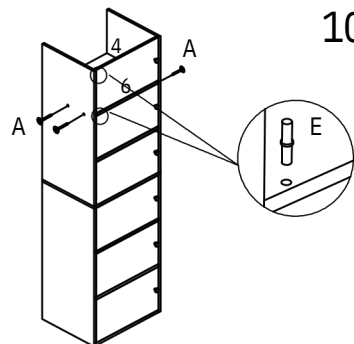
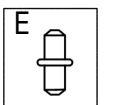
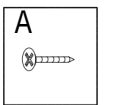

10

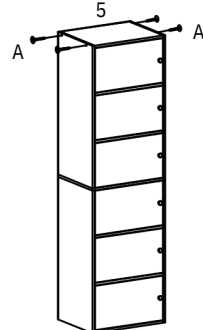
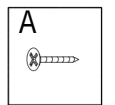

11

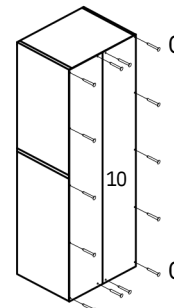
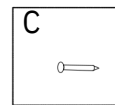

12

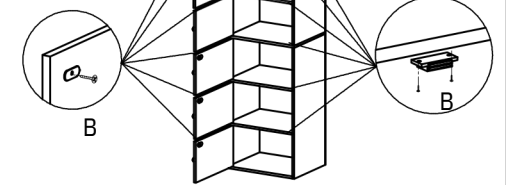
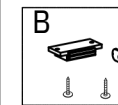

13